

Plastic Mold Infrared LEDs

KEDE1451M52

Features

- High output power
- Sharp directivity
- Direct modulation

Applications

- Optical switches
- Optical instruments
- Water sensors
- Humidity analysis

Dimensions (unit: mm)

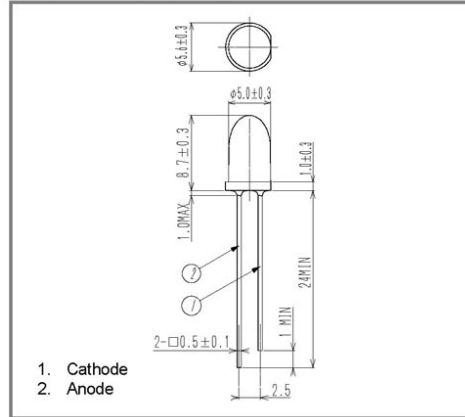

Specifications

Absolute Maximum Ratings

Parameter	Symbol	Value	Unit	Conditions
Forward current	I_F	100	mA	
Peak forward current	I_{FP}	1	A	Puls width=100 μ s, Duty ratio=1%
Reverse voltage	V_R	3	V	
Collector dissipation	P_D	130	mW	
Operating temperature	T_{opr}	-30 to +85		Avoid dew condensation
Storage temperature	T_{stg}	-30 to +100		Avoid dew condensation

Electrical and Optical characteristics

Parameter	Symbol	Value			Unit	Conditions
		Min.	Typ.	Max		
Forward voltage	V_F		0.8	1.3	V	$I_F=50$ mA
Reverse Current	I_R			10	μ A	$V_R=1$ V
Optical output power	P_O		2.2		mW	$I_F=50$ mA
Peak wavelength	ρ	1400	1450	1500	nm	$I_F=50$ mA
Spectral width			100		nm	$I_F=50$ mA
Half angle	2		10		deg	$I_F=50$ mA

Allowable Forward Current - Ambient Temperature

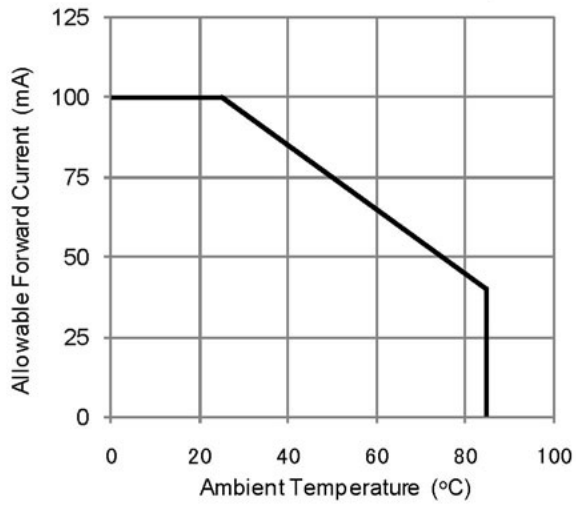

Optical Output Power - Forward Current

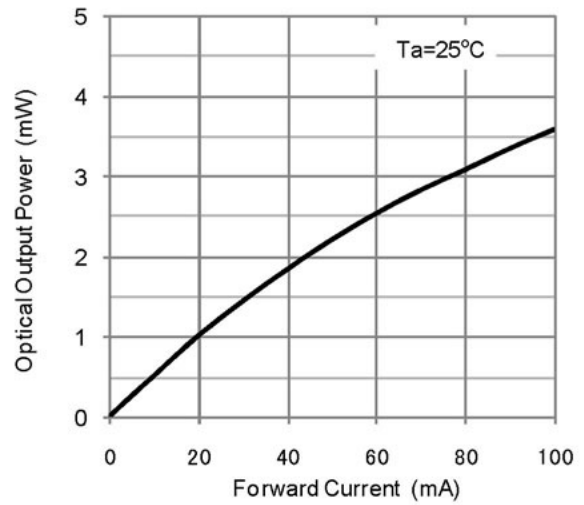

Forward Current - Forward Voltage

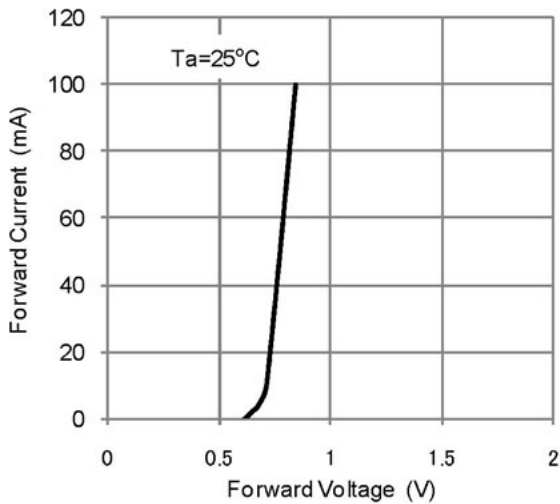

Relative Optical Output Power - Ambient Temperature

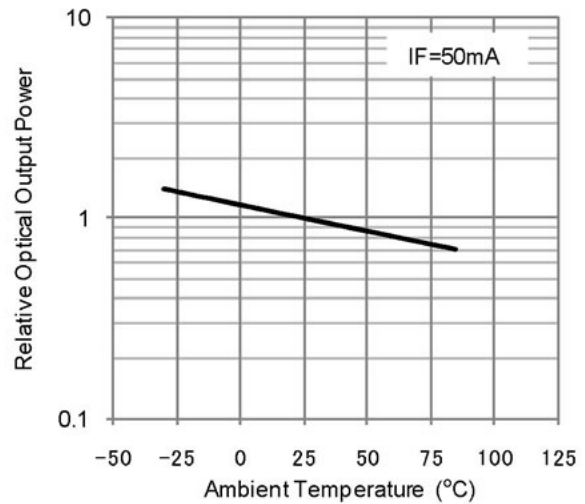

Spectral Distribution

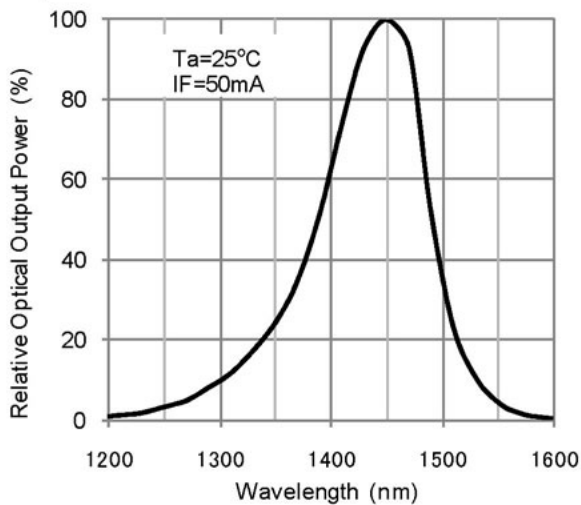

Directivity

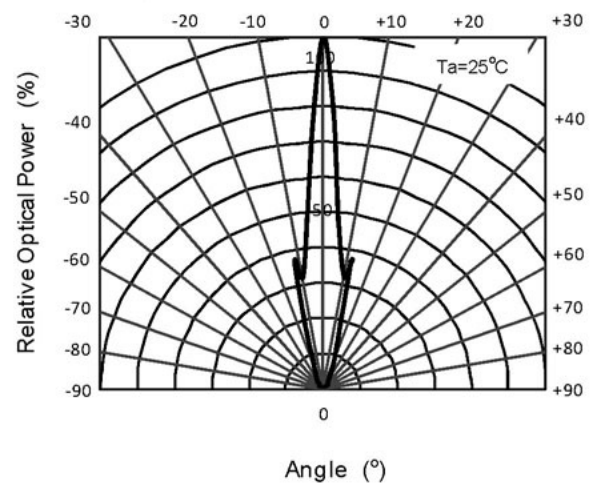

Specifications are subject to change without notice.