

SONY

Machine Vision Catalogue

Seeing the extraordinary in the everyday

IMAGE SENSING SOLUTIONS

Digital Interface GigE Vision

Digital Interface Camera Link

Digital Interface USB3.0 Vision

www.image-sensing-solutions.eu



Contents



Realise your vision

This latest edition of our machine vision catalogue features the complete 2017 range of Sony camera modules, including GigE and Camera Link models.

We've included a useful market overview, together with an introduction to our class-leading sensing and processing technologies that help realise your own vision for higher imaging performance, greater reliability and lower operating costs.

04-05	Heritage
06-09	Precision
10-11	Total Cost of Ownership
12-13	Machine Vision Overview
14-19	GigE Interface
20-25	Camera Link
26-29	USB3.0 Vision
30-31	Product Line-up 2017

Heritage



1978

1980

1983

1989

2002

110K pixels CCD
image sensor
developed

World-first CCD Video
camera
XC-1 launched

World first machine
vision camera XC-37
launched

Passport size
"Handy Cam"
CCD-TR55
launched

IP camera
launched

1/2 inch 250K
pixels CCD
launched



Giving a clearer picture with over 30 years of imaging innovation



2007

World-first Full HD FCB-H11 camera module launched



2010

Exview HAD CCD II technology launch



2015

First 4K industrial camera



2016

Introduction of Global shutter CMOS Pregius technology

At Sony we've been leading the way in machine vision and image sensing innovation for more than three decades.

We've consistently pushed the limits of imaging technology, from our introduction of the world's first CCD industrial video camera back in 1980.

And today we're creating even smarter, more sensitive digital camera modules - opening up exciting new possibilities to see the finest details as you've never seen them before. Whenever and wherever absolute clarity matters.

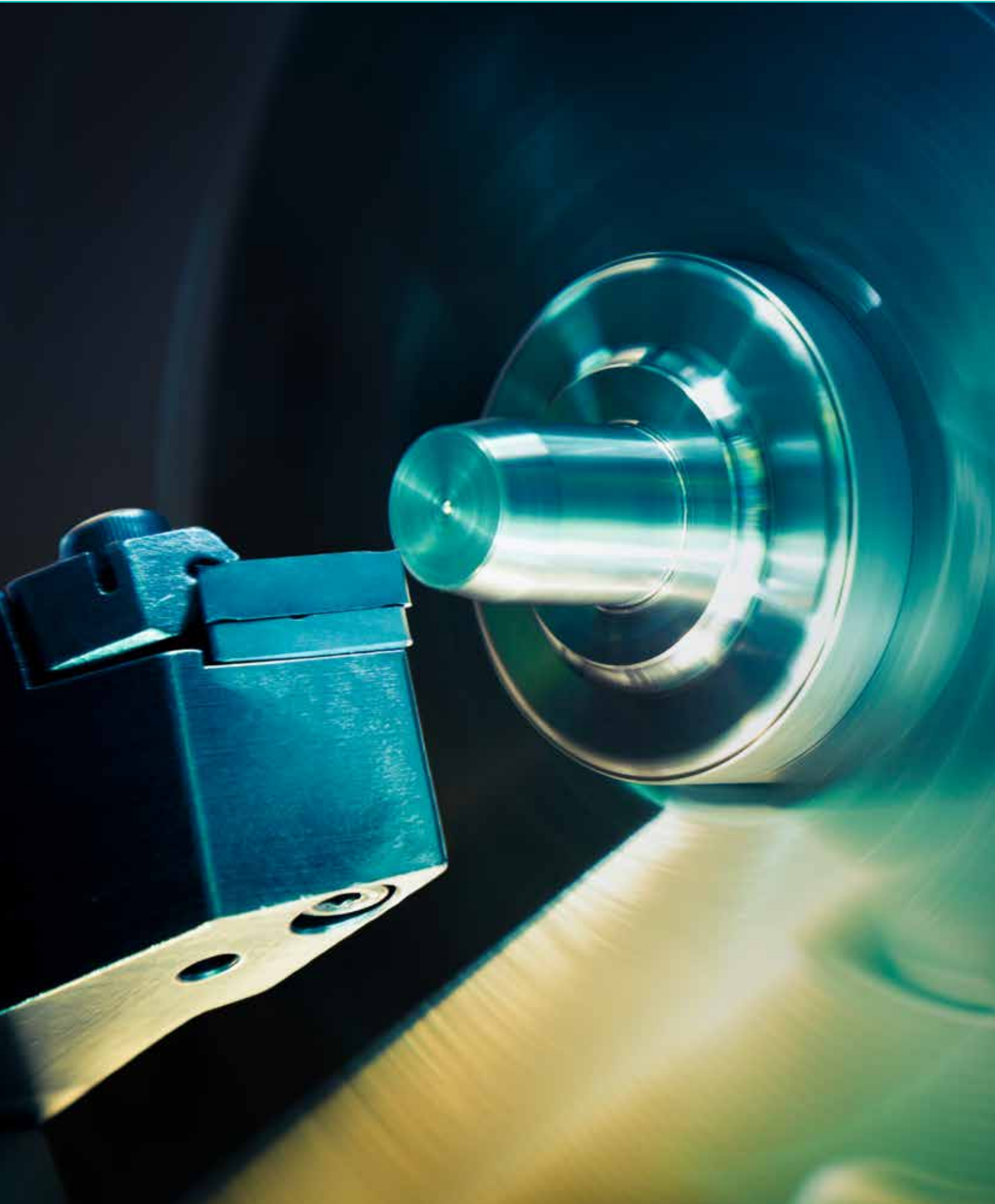



Total precision

You'll find our cameras hard at work in a wide range of machine vision environments where accurate, dependable imaging performance is paramount.

Absolute precision is designed into every Sony camera module. Image sensor and lens mount components are aligned to exceptionally fine tolerances during assembly. What's more, each module is subjected to stringent vibration, impact and environmental tests to assure industry-leading performance and long-term reliability in real-world conditions.

Accurate & dependable imaging

ACCURACY

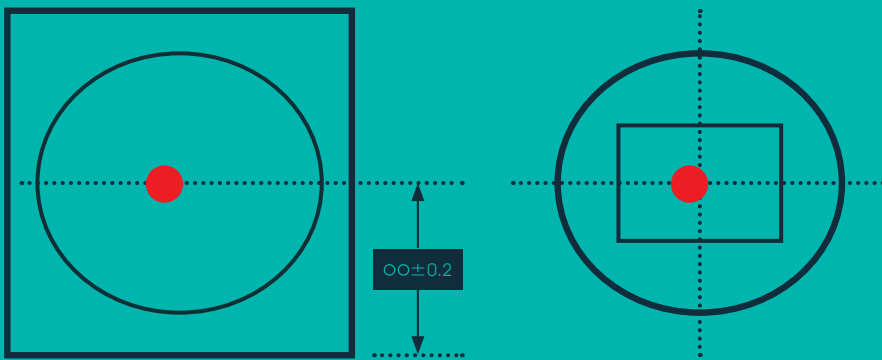

Lens-mount

Image sensor

Centering between lens-mount and image sensor

Alignment to within $\pm 0.2\text{mm}$

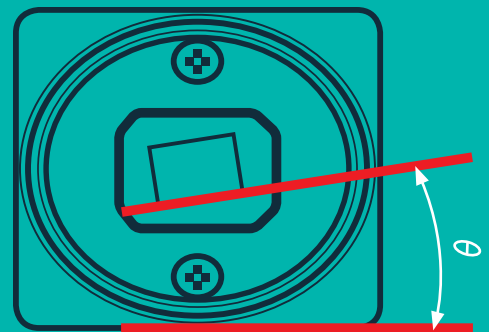

Angle of image sensor mounting

Alignment to within $\pm 1.0^\circ$



RELIABILITY

Demanding spec

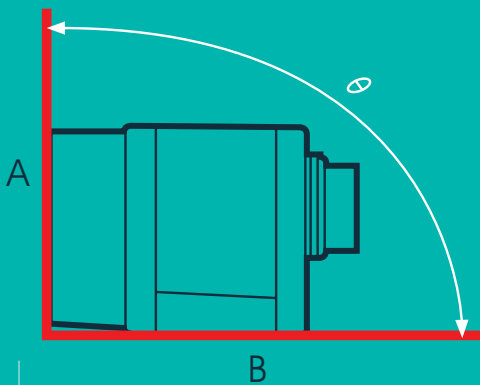

Right Angle between attachment A and B

Alignment to within $\pm 0.5^\circ$



Temperature operation and storing



Power supply voltage variation



Vibration



Impact



Packing falling / vibration



A clear vision for lower ownership costs

Recent advances in machine vision technologies have allowed Sony to capture images with unprecedented speed, quality and precision. Considering not just the sensor's capabilities but the environment it will be operating in, Sony has further improved image acquisition and overall camera performance for superior evaluation of the target object and more accurate results.

With its impressive track record in camera development and production, Sony cameras combine the best possible imaging quality from our industry-leading sensors with all round value-added features and performance.

The recent move to **Global Shutter CMOS technology** now enables an even greater array of capabilities. These allow improved imaging accuracy and speed, contributing greater value to processes and reducing overall system cost.

The **XCL-SG510 series of CameraLink cameras** captures fast moving objects with exceptional accuracy, even in variable lighting conditions or when shadows and glare present further challenges. Designed for use in factory automation and non-manufacturing markets such as Intelligent Traffic Surveillance, this series captures 5.1MP images at a very high frame rate of 154 fps. Additional features include region of interest and wide dynamic range.

In an industry first, the **XCG-CG510 series of GigE cameras** are capable of not just working as part of a system using the IEEE1588 precision time protocol, but acting as the master in it. This eliminates the need for additional hardware, thus reducing overall system cost.

Innovations in sensor development and camera design by Sony present ever more possibilities to system integrators, vision system designers and users. This improves control, accuracy and recognition in increasingly challenging circumstances where system failure is not an option. It's through this non-stop innovation that Sony continues to offer significant reductions in total ownership costs to customers.

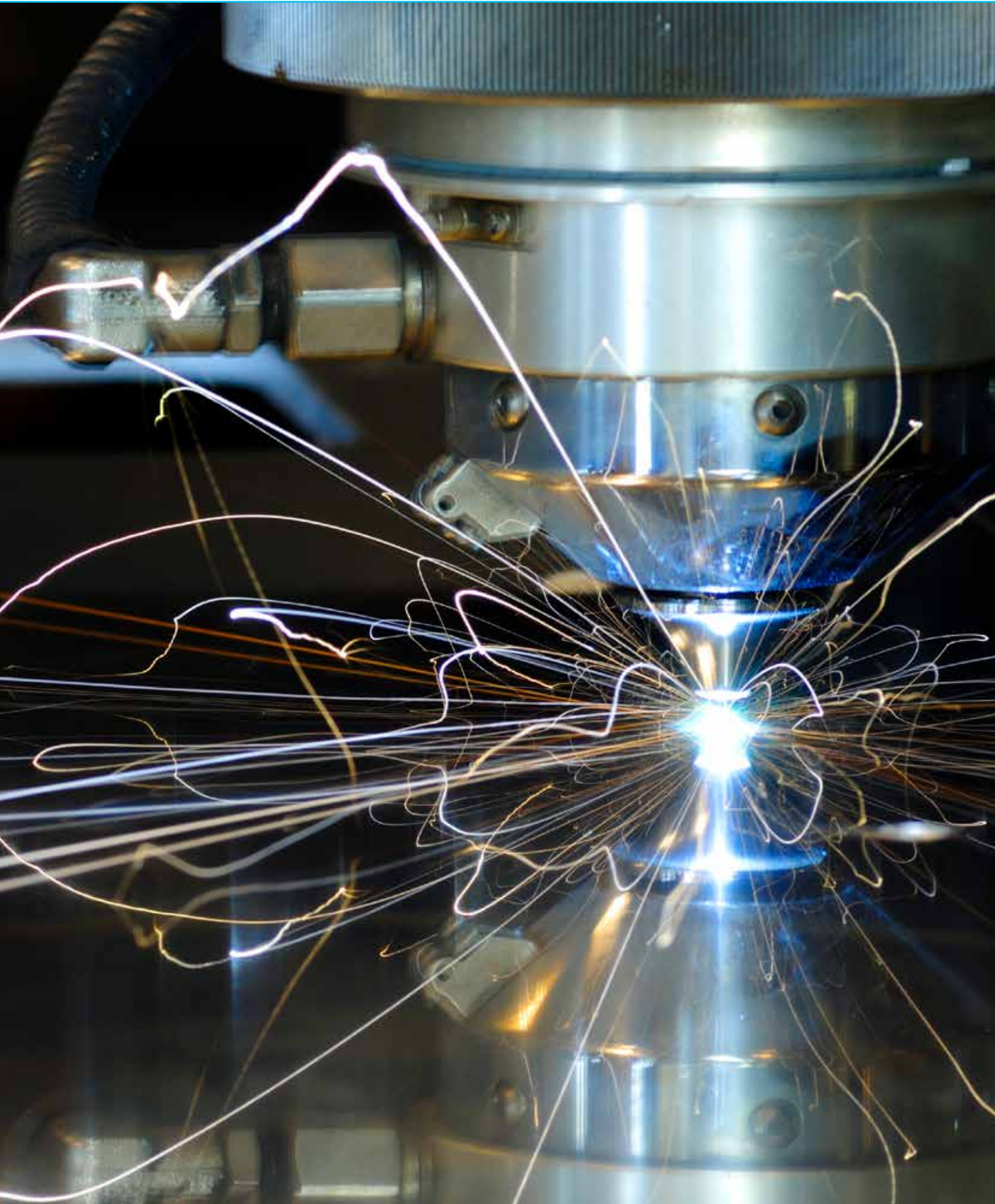

Machinery

Semiconductors
& Printing

PRODUCTS & SOLUTIONS

- High resolution sensor
- Colour camera
- USB & IEEE1394

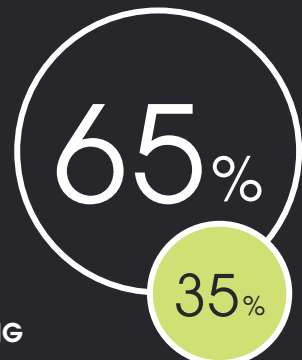
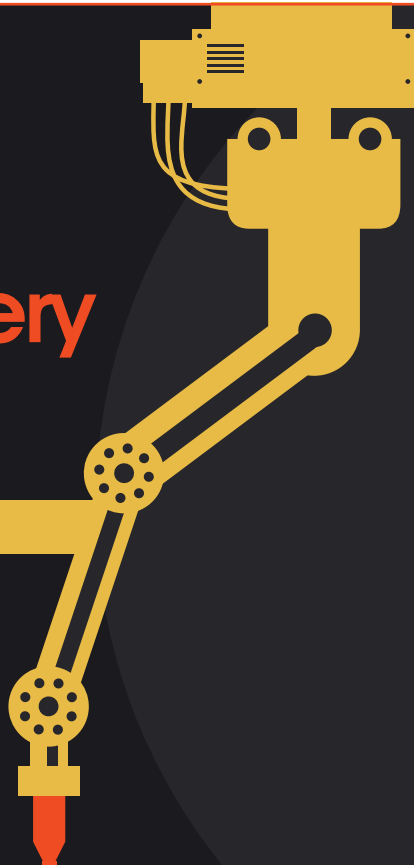

- MANUFACTURING
- NON-MANUFACTURING

The Machine Vision market in EMEA region spans a wide range of manufacturing- and non-manufacturing applications. Sony offers a complete range of cameras and modules with specialised features, ideally suited to the exacting demands of these diverse environments.

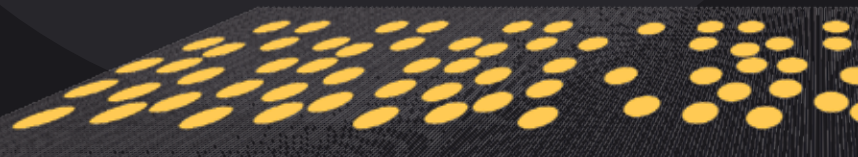

Measurement & Monitoring Reading

PRODUCTS & SOLUTIONS

- Digital Interface
- GigE (Long distance)



Inspection

Surfaces
Packaging
Quality
Glass
Automotive

PRODUCTS & SOLUTIONS

- High speed GSCMOS
- High resolution
- Digital interface
- GigE & Camera Link
- Software & added value

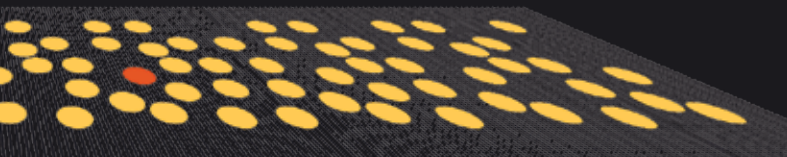

Life Science

Medical &
Pharmaceutics

PRODUCTS & SOLUTIONS

- High resolution sensor
- Colour camera
- IEEE1394 & USB

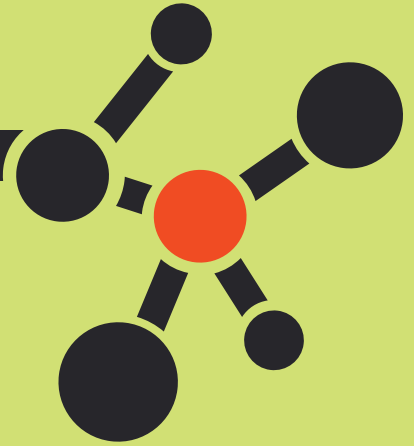

PRODUCTS & SOLUTIONS

Logistics
Mail sorting

- Global Shutter CMOS camera with high resolution
- IEEE1394 & GigE



ITS

Traffic & Surveillance

PRODUCTS & SOLUTIONS

- Global Shutter CMOS camera
- High Frame Rate CMOS camera module
- AF built-in lens
- Software added value





Colour and detail matter



GigE Interface

XCG Series Digital Cameras

Our space-saving XCG Series cameras incorporate GigE Vision, the high performance network interface standard developed specifically for industrial imaging and machine vision applications.

Every XCG Series camera features the best in Sony image sensing technology, in a compact form factor that's optimised for smooth integration in a wide range of industrial vision environments. Drawing directly on Sony's unmatched heritage in sensor innovation and integrated camera design, it offers a potent combination of performance, quality and rock-solid reliability from a name that's trusted worldwide.



XCG-CG160 / XCG-CG160C

The XCG-CG160 (black & white) and XCG-CG160C (colour) 1/2.9-type Global Shutter CMOS SXGA resolution colour camera

The XCG-CG160 and XCG-CG160C combines the best of Sony technology in a convenient form factor which is optimised for use within both the Industrial Vision and non-manufacturing vision markets.

CMOS TECHNOLOGY



KEY FEATURES

- Sony IMX273 1.6MP
- 75 fps
- Compact size
- GigE Vision 2.0/1.2
- Gigabit Ethernet with PoE
- IEEE1588 (PTP) compliant
- Area Gain
- Advanced Image Processing
- Defect Pixel Correction
- Shading Correctio

KEY SPECIFICATIONS

	XCG-CG240 / XCG-CG240C
Dimensions (W x H x D)	29 x 29 x 42 mm (excluding protrusions)
Number of effective pixels (H x V)	1,936 x 1,216
Weight	65 g
Frame rate (8 bit)	41 fps
Power consumption	DC +12 V : 3.0 W (max.) IEEE802.3af : 3.6 W (max.)

XCG-CG240 / XCG-CG240C

XCG-CG240 (black & white) and XCG-CG240C (colour) machine vision cameras featuring 1/1.2-type Global Shutter CMOS sensor with Pregius technology

The XCG-CG240 and XCG-CG240C offer a resolution of 1936 (H) x 1216 (V) with a frame rate of 41 fps, and support GigE Vision 1.2 / 2.0 with one-cable PoE capability.

CMOS TECHNOLOGY



KEY FEATURES

- Sony Pregius IMX249 2.4MP
- 41 fps
- Compact cubic size
- GigE Vision 2.0/1.2 compliant
- Gigabit Ethernet with PoE
- IEEE1588 compliant
- Area Gain
- Advanced Image Processing
- Defect Pixel Correction
- Shading Correction
- Trigger Mode
- Single ROI

KEY SPECIFICATIONS

	XCG-CG240 / XCG-CG240C
Dimensions (W x H x D)	29 x 29 x 42 mm (excluding protrusions)
Number of effective pixels (H x V)	1,936 x 1,216
Weight	65 g
Frame rate (8 bit)	41 fps
Power consumption	DC +12 V : 3.0 W (max.) IEEE802.3af : 3.6 W (max.)



XCG-CG510 / XCG-CG510C

XCG-CG510 (black & white) and XCG-CG510C (colour) machine vision cameras featuring 2/3-type Global Shutter CMOS sensor with Pregius technology

The XCG-CG510 and XCG-CG510C offer a resolution of 2464 (H) x 2056 (V) with a frame rate of 23 fps, and support GigE Vision 1.2 / 2.0 with one-cable PoE capability.



CMOS TECHNOLOGY

KEY FEATURES

- Sony IMX264 5.1 MP
- 23fps
- Compact cubic size
- GigE Vision 2.0/1.2
- Gigabit Ethernet with PoE
- IEEE1588 compliant
- Area Gain
- Advanced Image Processing
- Defect Pixel Correction
- Shading Correction
- Trigger Mode
- Single ROI

KEY SPECIFICATIONS

	XCG-CG510 / XCG-CG510C
Dimensions (W x H x D)	29 x 29 x 42 mm (excluding protrusions)
Number of effective pixels (H x V)	2,464 x 2,056
Weight	65 g
Frame rate (8 bit)	23 fps
Power consumption	DC +12 V : 3.0 W (max.) IEEE802.3af : 3.7 W (max.)

XCG-C30 / XCG-C30C

XCG-C30 (black & white) and XCG-C30C (colour) cubic-type machine vision camera modules with 1/3-type CCD sensor

The XCG-C30 and XCG-C30C offer a resolution of 640 (H) x 480 (V) with a high frame rate of up to 130 fps (non-PoE), and support GigE Vision 2.0 / 1.2 via Gigabit Ethernet with PoE capability.



CCD TECHNOLOGY

KEY FEATURES

- High frame rate
- Compact size
- GigE Vision 2.0/1.2
- Gigabit Ethernet with PoE
- 6-pin connector (supports DC 12 V)
- Shorter trigger latency
- Trigger range control (noise reduction)
- Sensitivity control
- Temperature read out

KEY SPECIFICATIONS

	XCG-C30 / XCG-C30C
Dimensions (W x H x D)	29 x 29 x 42 mm (excluding protrusions)
Number of effective pixels (H x V)	658 x 494
Weight	66 g
Frame rate (8 bit)	130 fps (Non-PoE)
Power consumption	DC +12 V : 3.2 W (max.) IEEE802.3af : 3.8 W (max.)



CCD TECHNOLOGY

XCG-C130 / XCG-C130C

XCG-C130 (black & white) and XCG-C130C (colour) cubic-type machine vision camera modules with 1/3-type CCD sensor

The XCG-130 and XCG-130C offer a resolution of 1280 (H) x 960 (V) with a frame rate of 31 fps, and support GigE Vision 2.0 / 1.2 via Gigabit Ethernet with PoE capability.



KEY FEATURES

- High frame rate
- Compact size
- GigE Vision 2.0/1.2
- Gigabit Ethernet with PoE
- 6-pin connector (supports DC 12 V)
- Shorter trigger latency
- Trigger range control (noise reduction)
- Temperature read out

KEY SPECIFICATIONS

	XCG-C130 / XCG-C130C
Dimensions (W x H x D)	29 x 29 x 42 mm (excluding protrusions)
Number of effective pixels (H x V)	1,296 x 966
Weight	66 g
Frame rate (8 bit)	31 fps
Power consumption	DC +12 V : 3.2 W (max.) IEEE802.3af: 3.4w (max.)

XCG-5005E / XCG-5005CR

XCG-5005E (black & white) and XCG-5005CR (colour) cameras incorporate the GigE Vision interface, which is specifically standardised for machine vision applications based on Gigabit Ethernet technology

This interface enables the cameras to transfer a large amount of data over long distances. The use of an Ethernet cable and the availability of a wide variety of peripheral devices contribute to significant cost reduction when designing a complete vision system.

CCD TECHNOLOGY



KEY FEATURES

- GigE Vision Interface
- High Frame Rate Image Transfer
- Bulk Trigger Mode/ Sequential Trigger Mode
- Low Power Consumption and Compact Design
- High Resistance to Shock and Vibration

KEY SPECIFICATIONS

	XCG-5005E / XCG-5005CR
Dimensions (W x H x D)	44 x 33 x 67.5 mm (not including protruding parts)
Number of effective pixels (H x V)	2456 x 2058
Weight	145 g
Frame rate (8 bit)	15 fps
Power consumption	4.3 W



looks familiar. performs better.



Our brand new SXGA digital cameras are worthy of everyone's attention.

Available with a choice of GigE and USB 3.0 interfaces, they're the clear choice for a wide range of imaging applications, from general inspection and alignment to robotics, medical and ITS. With a resolution of 1.6 megapixels using our latest next-generation Pregius sensor the new XCU-CG160 & XCG-CG160 ensure crisply detailed SXGA colour or monochrome images from 75fps to over 100fps. They're an ideal upgrade from your current CCD cameras, with a familiar form factor – plus all the accuracy and long-term durability you'd expect from Sony.

Take a closer look today at image-sensing-solutions.eu

Smart, speedy, sensitive

Camera Link

XCL Series Digital Cameras

Offering exceptional resolution at very high frame rates, every XCL Series camera delivers enhanced unrivalled picture quality.

Sony's latest cameras incorporate Sony Pregius Global Shutter CMOS sensor technology resulting in a highly durable camera which combines high frame rate and high sensitivity with a unique range of valuable features including Wide Dynamic Range, shading correction and defect correction capabilities.



IMAGE SENSING SOLUTIONS

Digital Interface Camera Link



XCL-CG510 / XCL-CG510C

The XCL-CG510 (black & white) and XCL-CG510C (colour) are the latest industrial cameras from Sony to incorporate Sony Pregius GSCMOS sensor technology.

Drawing upon Sony's market leading Global Shutter CMOS sensor technology the XCL-CG510C combines the highly innovative, high speed IMX264 5.1MP GSCMOS sensor with Sony's rich heritage of complete camera technology and a Camera Link interface, bringing the best combination of performance and quality from a brand you can trust.



CMOS TECHNOLOGY

KEY FEATURES

- Unique Image Processing
- High Frame Rate Image Transfer
- Shading Correction
- Defect Correction
- Temperature Readout
- Memory Channel (User Set)
- Bulk Trigger Mode & Sequential Trigger Mode
- Look-up Table (LUT)
- Industrial Design
- Wide dynamic range, Area exposure

KEY SPECIFICATIONS

	XCL-CG510 / XCL-CG510C
Dimensions (W x H x D)	42 x 29 x 29 mm (excluding protrusions)
Number of effective pixels (H x V)	2,464 x 2,056
Weight	65 g
Frame rate (8 bit)	23 fps
Power consumption	3.0 W

XCL-SG510 / XCL-SG510C

The XCL-SG510 (black & white) and XCL-SG510C (colour) cameras incorporate Pregius Global Shutter CMOS sensor technology

The XCL-SG510 and XCL-SG510C combine innovative, high speed IMX250 5.1MP Global Shutter CMOS sensor with Sony's rich heritage of complete camera technology and a Camera Link interface.



CMOS TECHNOLOGY

KEY FEATURES

- Unique Image Processing
- High Frame Rate Image Transfer
- Shading Correction
- Defect Correction
- Temperature Readout
- Memory Channel (User Set)
- Bulk Trigger Mode & Sequential Trigger Mode
- Look-up Table (LUT)
- Industrial Design
- Wide dynamic range, Area exposure

KEY SPECIFICATIONS

	XCL-SG510 / XCL-SG510C
Dimensions (W x H x D)	44 x 44 x 30 mm (excluding protrusions)
Number of effective pixels (H x V)	2,464 x 2,056
Weight	96 g
Frame rate (8 bit)	16 fps (Base 1 tap), 32 fps (Base 2 tap), 48 fps (Base 3 tap), 64 fps (Medium 4 tap), 124 fps (Full 8 tap), 154 fps (80 bit 10 tap)
Power consumption	5.0 W (max.) PoCL or DC in



XCL-C30 / XCL-C30C

XCL-C30 (black & white) and XCL-C30C (colour) cameras incorporate a 1/3-type sensor which delivers high sensitivity

Ideal for various applications such as ITS (Intelligent Transportation Systems) and sports shooting, as well as traditional machine vision applications.

CCD TECHNOLOGY



KEY FEATURES

- Shading Correction
- Defect Correction
- Temperature Readout
- Sensitivity Control
- Memory Channel
- Bulk Trigger Mode & Sequential Trigger Mode
- Look-up Table (LUT)
- Trigger Noise Filtering

KEY SPECIFICATIONS

	XCL-C30 / XCL-C30C
Dimensions (W x H x D)	29 x 29 x 30 mm (excluding protrusions)
Number of effective pixels (H x V)	658 x 494
Weight	56 g
Frame rate (8 bit)	130 fps
Power consumption	2.8 W (typical)

XCL-C130 / XCL-C130C

XCL-C130 (black & white) and XCL-C130C (colour) cameras incorporate a 1/3-type EXview HAD CCD™ sensor which delivers high sensitivity

Ideal for various applications such as ITS (Intelligent Transportation Systems) and sports shooting, as well as traditional machine vision applications.

CCD TECHNOLOGY



KEY FEATURES

- Shading Correction
- Defect Correction
- Temperature Readout
- Memory Channel
- Bulk Trigger Mode & Sequential Trigger Mode
- Near-infrared Sensitivity
- Look-up Table (LUT)
- Trigger Noise Filtering
- Pulse Train Generator

KEY SPECIFICATIONS

	XCL-C130 / XCL-C130C
Dimensions (W x H x D)	29 x 29 x 30 mm (excluding protrusions)
Number of effective pixels (H x V)	1,296 x 966
Weight	56 g
Frame rate (8 bit)	31 fps
Power consumption	2.4 W (typical)



XCL-C280 / XCL-C280C

XCL-C280 (black & white) and XCL-C280C (colour) cameras incorporate a 1/1.8-type EXview HAD CCD II™ sensor which delivers high sensitivity with 2.8MP resolution

Ideal for various applications such as ITS (Intelligent Transportation Systems) and sports shooting, as well as traditional machine vision applications.

CCD TECHNOLOGY



KEY FEATURES

- Shading Correction
- Defect Correction
- Temperature Readout
- Sensitivity Control
- Memory Channel
- Bulk Trigger Mode & Sequential Trigger Mode
- Near-infrared Sensitivity
- Look-up Table (LUT)
- Trigger Noise Filtering
- Pulse Train Generator

KEY SPECIFICATIONS

	XCL-C280 / XCL-C280C
Dimensions (W x H x D)	29 x 29 x 30 mm (excluding protrusions)
Number of effective pixels (H x V)	1,940 x 1,460
Weight	56 g
Frame rate (8 bit)	26 fps
Power consumption	3.0 W (typical)

XCL-S900 / XCL-S900C

XCL-S900 (black & white) and XCL-S900C (colour) cameras offer 9MP resolution and high frame rates, delivering exceptional picture quality that analogue cameras cannot achieve

Both cameras incorporate a 1/1-type EXview HAD CCD II sensor which provides extremely high sensitivity.

CCD TECHNOLOGY



KEY FEATURES

- Near-infrared Sensitivity
- High Frame Rate Image Transfer
- Shading Correction
- Defect Correction
- Temperature Readout
- Sensitivity Control
- Memory Channel (User-set)
- Bulk Trigger Mode & Sequential Trigger Mode
- Look-up Table (LUT)
- Trigger Noise Filtering
- Pulse Train Generator

KEY SPECIFICATIONS

	XCL-S900 / XCL-S900C
Dimensions (W x H x D)	50 x 50 x 57.5 mm (excluding protrusions)
Number of effective pixels (H x V)	3,388 x 2,712
Weight	181 g
Frame rate (8 bit)	18 fps (4ch), 9 fps (2ch), 5 fps (1ch)
Power consumption	6.0 W



Profit from precision



It's all in the details. Inspect our smart, speedy, sensitive new camera modules.

Sony's latest digital camera modules are precisely what your business is looking for. The 2/3-type 5MP Global Shutter CMOS sensor eliminates focal plane distortion, capturing accurate images on fast-moving inspection lines. High speed shooting at a blazing 150fps shortens takt time. Powerful processing boosts dynamic range and ensures accurate exposure of selected areas of interest. And with exceptional sensitivity, you'll see finer details while spending less on ambient lighting.

Realise your vision. And enjoy the returns.
image-sensing-solutions.eu



Universally appealing



USB3.0 Vision

XCU Series Digital Cameras

Available in black & white and colour versions, our new XCU Series cameras makes the most of the increasingly popular USB 3.0 Vision interface standard.

You'll enjoy the same premium imaging performance as our XCL range, with Pregius Global Shutter CMOS sensor technology assuring an optimum blend of resolution, speed and sensitivity. Providing a simple migration path from CCD, the compact XCU Series is a compelling choice for production and inspection environments where USB 3.0 Vision is the preferred architecture.



CMOS TECHNOLOGY

XCU-CG160 / XCU-CG160C

The XCU-CG160 (black & white) & XCU-CG160C (Colour) combines the best of Sony technology in a convenient form factor which is optimised for use within both the Industrial Vision and non-manufacturing vision markets

Drawing upon Sony's market leading Global Shutter CMOS sensor technology, combining the IMX273 1.6MP sensor in SXGA resolution with a rich heritage of complete camera technology, bringing the best combination of performance and quality from a brand you can trust.



KEY FEATURES

- Sony IMX273 1.6MP
- Approx. 100fps
- Compact size
- USB3.0 Vision 1.0.1
- Area Gain
- Advanced Image Processing
 - Defect Pixel Correction
 - Shading Correction

KEY SPECIFICATIONS

	XCU-CG160 / XCU-CG160C
Dimensions (W x H x D)	29 x 29 x 30 mm (excluding protrusions)
Number of effective pixels (H x V)	1,456 x 1,088
Weight	56 g
Frame rate (8 bit)	100 fps
Power consumption	3.0 W (typical)

Migration from Sony CCD to Sony CMOS, the advantages of IMX273 over ICX445

Our new XCU-CG160/C and XCG-CG160/C cameras include the Sony IMX273 1.6MP SXGA resolution sensor which provides a low-disruption pathway to move from CCD to GSCMOS.

The XCU-GC160/C and XCG-CG160/C cameras are therefore an ideal replacement for industrial cameras using the highly-regarded Sony ICX445 CCD sensor.

As the table opposite shows, the IMX273 shares comparable sensor and pixel size characteristics with the ICX445, but offers significant technological improvements in sensitivity, dynamic range, noise reduction and frame rate capability. The camera's performance is further enhanced through Sony's world renowned know how in camera design.

	IMX273 B&W/Colour	ICX445 B&W/Colour
Optical format	1/2.9-type	1/3-type
Resolution (H x V)	1,456 x 1,088	1,296 x 966
Sensor type	CMOS	CCD
Pixel size (µm)	3.45 x 3.45	3.75 x 3.75
Frame rate (fps)	75/75 with GigE (Sony XCG)	30/22 with GigE
Shutter type	Global Shutter	Global Shutter
Saturation signal (min.) (mV)	1001	350
Sensitivity (min.) (mV)	790 (F8) / 970 (F5.6)	300 (F8) / 300 (F5.6)
Dark signal (Max.) (mV)	0.19	2
Dynamic range (dB)	73.6	59.6
SNR (max.) (dB)	40.4	39.4



looks
familiar.
performs
better.



**The new SXGA range from Sony;
worthy of everyone's attention**

Available with a choice of GigE and USB 3.0 interfaces and using our brand new IMX273 Pregius sensor the new XCU-CG160 & XCG-CG160 provide an ideal digital upgrade path from your current ICX445 CCD-based camera, along with all the performance and long-term durability you'd expect in a complete camera from Sony. With a resolution of 1.6MP crisp & detailed SXGA colour or monochrome images from 75fps to 100fps become a reality, making them suitable for a wide range of imaging applications, from general inspection and alignment, to robotics, medical and ITS.

Take a closer look today at image-sensing-solutions.eu

Product Line-up 2017

Model	Image Device	Pixel Resolution	Lens Mount	Size/Mass	Key Features
DIGITAL INTERFACE CAMERA LINK					
XCL-C30	1/3" HAD CCD (BW)	640 x 480 (VGA) 130 fps	C mount	29 x 29 x 30 mm / 56 g	3x3 filter, Shading correction, Defect correction, Trigger mode, PoCL & non-PoCL interface, High shock and vibration resistance
XCL-C30C	1/3" HAD CCD (Colour)	640 x 480 (VGA) 130 fps	C mount		3x3 filter, Shading correction, One push WB, Defect correction, Trigger mode, PoCL & non-PoCL interface, High shock and vibration resistance
XCL-C32C	1/2" HAD CCD (Colour)	640 x 480 (VGA) 104 fps	C mount		3x3 filter, Shading correction, One push WB, Defect correction, Trigger mode, PoCL & non-PoCL interface, High shock and vibration resistance
XCL-C130	1/3" EXview HAD CCD (BW)	1280 x 960 (SXGA) 31 fps	C mount		Near infrared sensitivity using EXview HAD Sony CCD, 3x3 filter, Shading correction, Defect correction, Trigger mode, PoCL & non-PoCL interface, High shock and vibration resistance
XCL-C130C	1/3" EXview HAD CCD (Colour)	1280 x 960 (SXGA) 31 fps	C mount		3x3 filter, Shading correction, One push WB, Defect correction, Trigger mode, PoCL & non-PoCL interface, High shock and vibration resistance
XCL-C280	1/1.8" EXview HAD CCD II (BW)	1920 x 1440 (2.8 M) 26 fps	C mount		Near infrared sensitivity using EXview HAD Sony CCD II, 3x3 filter, Shading correction, Defect correction, Trigger mode, PoCL & non-PoCL interface, High shock and vibration resistance
XCL-C280C	1/1.8" EXview HAD CCD II (Colour)	1920 x 1440 (2.8 M) 26 fps	C mount		3x3 filter, Shading correction, One push WB, Defect correction, Trigger mode, PoCL & non-PoCL interface, High shock and vibration resistance
XCL-C500	2/3" Super HAD CCD (BW)	2448 x 2048 (5 M) 15fps	C mount		3x3 filter, Shading correction, Defect correction, Trigger mode, PoCL & non-PoCL interface, High shock and vibration resistance
XCL-C500C	2/3" Super HAD CCD (Colour)	2448 x 2048 (5 M) 15fps	C mount		3x3 filter, Shading correction, One push WB, Defect correction, Trigger mode, PoCL & non-PoCL interface, High shock and vibration resistance
XCL-CG510	Sony Pregius IMX-264 image sensor (B&W)	2448 x 2048 (5 M) 15fps	C mount		42 x 29 x 29 mm / 65 g
XCL-CG510C	Sony Pregius IMX-264 image sensor (Colour)	2448 x 2048 (5 M) 15fps	C mount	Near infrared sensitivity using EXview HAD CCD II, Binning/partial scan, 3x3 filter, Shading correction, Defect correction, Trigger mode, non-PoCL interface, High shock and vibration resistance	
XCL-S900	1" EXview HAD CCD II (BW)	3384 x 2704 (9 M) 18 fps	C mount	50 x 50 x 57.5 mm / 181 g	3x3 filter, Shading correction, One push WB, Defect correction, Trigger mode, Camera Link BASE interface, High shock and vibration resistance
XCL-S900C	1" EXview HAD CCD II (Colour)	3384 x 2704 (9 M) 18 fps	C mount		Unique Image Processing (wide dynamic range, frame accumulation, area exposure, area gain, Multi-Region of Interest, shading correction)
XCL-SG510	Sony Pregius IMX-250 image sensor (B&W)	2464 X 2056 154 fps	C mount	44 x 44 x 30 mm / 96 g	Unique Image Processing (wide dynamic range, frame accumulation, area exposure, area gain, Multi-Region of Interest, shading correction)
XCL-SG510C	Sony Pregius IMX-250 image sensor (Colour)	2464 X 2056 154 fps	C mount		B/W High Resolution & Sensitivity - 15/s Partial Scan, White Balance, Digital RGB 24 Bit, Camera Link Standard Conformity, Monitor Output, Partial Scanning, High shock and vibration resistance
XCL-U1000	1/1.8" Super HAD CCD (BW)	1600 X 1200 (UXGA) 15fps	C mount	56 x 44 x 95 mm / 250 g	Colour, High Resolution & Sensitivity - 15/s Partial Scan, White Balance, Digital RGB 24 Bit, Camera Link Standard Conformity, Monitor Output, Partial Scanning, High shock and vibration resistance
XCL-U1000C	1/1.8" Super HAD CCD (Colour)	1600 X 1200 (UXGA) 15fps	C mount		PoCL / Camera Link Standard (switchable) High Resolution & Sensitivity - 15/s, Compact and Lightweight with low power consumption, External Trigger, Built-in test pattern, Partial Scan function, Hardware Processing, High shock and vibration tolerance
XCL-U100	1/1.8" Super HAD CCD (BW)	1600 X 1200 (UXGA) 15fps	C mount	29 x 29 x 30 mm / 55g	Ultra High Resolution Image Capture, supports both PoCL and Standard Camera Link (base configuration), vertical and Horizontal Partial Scanning, Hardware Pre-processing, High shock and vibration Resistance
XCL-5005	2/3" Super HAD CCD (BW)	2448 x 2050 (5 M) 15fps	C mount		44 x 44 x 57.5 mm / 130g
XCL-5005CR	2/3" Super HAD CCD (Colour)	2448 x 2050 (5 M) 15fps	C mount		
DIGITAL INTERFACE GIGE VISION					
XCG-SX99E	2/3" EXview HAD CCD (BW)	1360 x 1024 (SXGA) 27 fps	C mount	44 x 33 x 67.5 mm / 145 g	Transmission of uncompressed image data at 1000Mbps, over distances of 100m; high resolution, 27fps
XCG-H280E	2/3" EXview HAD CCD II (BW)	1920 x 1440 (2.8 M) 32 fps	C mount		High frame rate: Full HD (1920 x 1080) 59 fps (4 ch), 32 fps (2 ch), Near infrared sensitivity, Memory shot, Binning/Partial scan, Trigger mode
XCG-U100E	1/1.8" Super HAD CCD (BW)	1600 X 1200 (UXGA) 15fps	C mount	44 x 33 x 67.5 mm / 145 g	Transmission of uncompressed image data at 1000Mbps, over distances of 100m; high resolution, 15fps
XCG-U100CR	1/1.8" Super HAD CCD (Colour)	1600 X 1200 (UXGA) 27 fps	C mount		Transmission of uncompressed image data at 1000Mbps, over distances of 100m; high resolution, 27 fps
XCG-CG160	Sony Pregius IMX273 image sensor (B&W)	1456 x 1088 70 fps	C mount	29 x 29 x 42 mm / 65 g	Sony IMX273 1.6MP, 75 fps, Compact size, GigE Vision 2.0/1.2, Gigabit Ethernet with PoE, IEEE1588 (PTP) compliant, Area Gain, Advanced Image Processing - Defect Pixel Correction - Shading Correction
XCG-CG160C	Sony Pregius IMX273 image sensor (Colour)	1456 x 1088 70 fps	C mount		Sony IMX273 1.6MP, 75 fps, Compact size, GigE Vision 2.0/1.2, Gigabit Ethernet with PoE, IEEE1588 (PTP) compliant, Area Gain, Advanced Image Processing - Defect Pixel Correction - Shading Correction
XCG-CG240	Sony Pregius IMX273 image sensor (B&W)	1920 x 1200 41 fps	C mount	29 x 29 x 42 mm / 65 g	Compact cubic size, Area Gain, defect pixel correction, shading correction, PoE/DC12V support, IEEE1588 compliant, noise filter, LUT, short latency, external & software trigger, partial scan, High shock and vibration resistance
XCG-CG240C	Sony Pregius IMX249 image sensor (Colour)	1920 x 1200 41 fps	C mount		Compact cubic size, Area Gain, defect pixel correction, shading correction, PoE/DC12V support, IEEE1588 compliant, noise filter, LUT, short latency, external & software trigger, partial scan, High shock and vibration resistance
XCG-CG510	Sony Pregius IMX264 image sensor (B&W)	2448 X 2048 23 fps	C mount	29 x 29 x 42 mm / 65 g	Compact cubic size, Area Gain, defect pixel correction, shading correction, PoE/DC12V support, IEEE1588 compliant, noise filter, LUT, short latency, external & software trigger, partial scan, High shock and vibration resistance
XCG-CG510C	Sony Pregius IMX264 image sensor (Colour)	2448 X 2048 23 fps	C mount		Compact cubic size, Area Gain, defect pixel correction, shading correction, PoE/DC12V support, IEEE1588 compliant, noise filter, LUT, short latency, external & software trigger, partial scan, High shock and vibration resistance
XCG-5005E	2/3" Super HAD CCD (BW)	2448 x 2048 (5 M) 15fps	C mount	44 x 33 x 67.5 mm / 145 g	Transmission of uncompressed image data at 1000Mbps, over distances of 100m; high resolution, 15 fps
XCG-5005CR	2/3" Super HAD CCD (Colour)	2448 x 2048 (5 M) 15fps	C mount		Transmission of uncompressed image data at 1000Mbps, over distances of 100m; high resolution, 15 fps

Digital Interface USB3.0 Vision

XC-CG160	Sony Pregius IMX273 image sensor (B&W)	1456 x 1088 100 fps	C mount	29 x 29 x 30 mm / 50g	Sony IMX273 1.6MP, Over 100 fps, Compact size, USB3.0 Vision 1.0.1, Area Gain, Advanced Image Processing - Defect Pixel Correction - Shading Correction
XC-CG160C	Sony Pregius IMX273 image sensor (Colour)	1456 x 1088 100 fps	C mount	29 x 29 x 30 mm / 50g	

NON-TV FORMAT

XC-HR50	1/3" IT Progressive Scan CCD (B/W)	648 x 494 (VGA)	C mount	29 x 29 x 30 mm / 50g	B/W, High Rate Scanning 60f/s Partial Scan – 240 f/s
XC-HR70	1/3" IT Progressive Scan CCD (B/W)	1024 x 768 (XGA)	C mount		B/W, High Rate Scanning 29f/s Partial Scan – 120 f/s
XC-HR90	1/3" IT Progressive Scan CCD (B/W)	1280 x 960 (SXGA)	C mount	29 x 29 x 63.5 mm / 80g	B/W, High Rate Scanning 30f/s (15f/s selectable), RS 232, Partial Scan, Low power consumption
XC-HR57	1/2" IT Progressive Scan CCD (B/W)	648 x 494 (VGA)	C mount	29 x 29 x 30 mm / 50g	B/W, High Rate Scanning 60f/s Partial Scan – 240 f/s
XC-HR58	1/2" IT Progressive Scan CCD (B/W)	767 x 580 (SVGA)	C mount		B/W, High Rate Scanning 60f/s Partial Scan – 200 f/s
XC-56	1/3" IT Progressive Scan CCD (B/W)	647 x 493 (VGA)	C mount		B/W, High Rate Scanning 60f/s
XC-56BB	1/3" IT Progressive Scan CCD (B/W)	647 x 493 (VGA)	NF mount	CHU 22 x 22 x 30 mm / 40g CCU 29 x 29 x 67 mm / 100g	B/W, 2 Piece Camera, Miniature Body, High Rate Scanning

TV FORMAT

XC-ES30*	1/3" IT HAD™ CCD (B/W)	752 x 485 (EIA) 736 x 575 (CCIR)	C mount	29 x 29 x 30 mm / 50g	B/W, High Sensitivity, Small & Lightweight, Simple/Flexible Trigger
XC-ES50*	1/2" IT HAD™ CCD (B/W)	752 x 485 (EIA) 736 x 575 (CCIR)	C mount	29 x 29 x 30 mm / 50g	B/W, High Sensitivity, Small & Lightweight, Simple/Flexible Trigger
XC-ES51*	1/2" IT HAD™ CCD (B/W)	752 x 485 (EIA) 736 x 575 (CCIR)	C mount	29 x 29 x 30 mm / 50g	B/W, High Sensitivity – 0.2 lux@ F1, nearly 2x Sensitivity of XC-ST50 and XC-ES50 models
XC-EI30*	1/3" IT HAD™ CCD (B/W)	752 x 485 (EIA) 736 x 575 (CCIR)	C mount		B/W, Near infrared Sensitivity, Small & Lightweight, Simple/Flexible Trigger
XC-EI50*	1/2" IT HAD™ CCD (B/W)	752 x 485 (EIA) 736 x 575 (CCIR)	C mount		B/W, Near infrared Sensitivity, Small & Lightweight, Simple/Flexible Trigger
XC-ST30*	1/3" IT HAD™ CCD (B/W)	752 x 485 (EIA) 736 x 575 (CCIR)	C mount	44 x 29 x 57.5 mm / 110g	B/W, High Sensitivity, Compact, Simple/Flexible Trigger, External Controls
XC-ST50*	1/2" IT HAD™ CCD (B/W)	752 x 485 (EIA) 736 x 575 (CCIR)	C mount		B/W, High Sensitivity, Compact, Simple/Flexible Trigger, External Controls
XC-ST70*	2/3" IT HAD™ CCD (B/W)	752 x 485 (EIA) 736 x 575 (CCIR)	C mount	44 x 29 x 57.5 mm / 105g	B/W, High Sensitivity, Compact, Simple/Flexible Trigger, External Controls
XC-505/P*	1/3 super HAD™ II Colour CDD	768 x 494 (NTSC) 752 x 582 (PAL)	NF mount	22 x 22 x 64 mm / 51 g	Colour Ultra Compact, RS-232C

COLOUR CAMERA BLOCK

4K series

FCB-ER8300	1/2.3-type Exmor R CMOS	Approx 8.93 Megapixels	12x Optical zoom, 12x Digital zoom	60 x 64 x 105 mm / 385 g	The new FCB-ER8300 block camera incorporates a 1/2.3-type Exmor R sensor capable of 4K resolution (3,840 x 2,160, QFHD) at up to 30p. The camera features a high-quality 12x optical zoom lens which – when combined with super resolution zoom – can maintain 4K resolution at up to 20x zoom, providing enhanced 4K visibility within a compact form factor. Auto ICR, Slow AE Response, Spherical Privacy Zone Masking, Defog, HLC, Noise reduction, Visibility enhancer, Digital output, Progressive Scan Mode, Motion Detection, Picture Freeze, Slow Shutter
-------------------	-------------------------	------------------------	---------------------------------------	--------------------------	--

Advanced HD series

FCB-EV7520	1/2.8-type Exmor R CMOS	Approx 2.13 Megapixels	30x Optical zoom, 12x Digital zoom	50.0 x 60.0 x 89.7 mm / 255g	FHD (1080p) model, 1080p60, Great FHD picture quality with 30x lens, Great sensitivity, in FHD Min illumination 0.35 Lux, Image Stabilisation, Stable zoom, Wide-D mode, Visibility Enhancer, 2D/3D Noise Reduction, Digital Output, Auto ICR, Slow AE Response, Spherical Privacy Zone Masking
FCB-EV7500	1/2.8-type Exmor CMOS	Approx 2.38 Megapixels	30x Optical zoom, 12x Digital zoom	50.0 x 60.0 x 89.7 mm / 260g	FHD (1080p) model, 1080p60, Great FHD picture quality with 30x lens, Great sensitivity in FHD Min illumination 0.35 Lux, Image Stabilisation, Stable zoom, Wide-D mode, Visibility Enhancer, 2D/3D Noise Reduction, Analogue and Digital Output, Auto ICR, Slow AE Response, Spherical Privacy Zone Masking
FCB-EV7300	1/2.8-type CMOS	Approx 2.38 Megapixels	20x Optical zoom, 12x Digital zoom	50 x 60 x 87.9 mm / 270g	FHD (1080p 60fps) model, Excellent FHD picture quality with 20x lens, Image Stabilisation, Stable zoom, Wide-D mode, Visibility Enhancer, 2D/3D Noise Reduction, Analogue and Digital Output, Auto ICR, Slow AE Response, Spherical Privacy Zone Masking
FCB-EV7310	1/2.8-type CMOS	Approx 2.38 Megapixels	20x Optical zoom, 12x Digital zoom	50 x 60 x 87.9 mm / 270g	FHD (1080p 60fps) model, Excellent FHD picture quality with 20x lens, Excellent IR sensitivity, Visibility Enhancer, 2D/3D Noise Reduction, Digital Output, Auto ICR, Slow AE Response, Spherical Privacy Zone Masking
FCB-EV7320	1/2.8-type Exmor R CMOS	Approx 2.13 Megapixels	20x Optical zoom, 12x Digital zoom	50.0 x 60.0 x 87.9 mm / 265g	Latest FHD (1080p 60fps) model, Excellent FHD picture quality with 20x lens, Image Stabilisation, Stable zoom, Wide-D mode, Visibility Enhancer, 2D/3D Noise Reduction, Digital Output, Auto ICR, Slow AE Response, Spherical Privacy Zone Masking
FCB-EV7100	1/2.8-type Exmor CMOS	Approx 2.38 Megapixels	10x Optical zoom, 12x Digital zoom	45.6 x 48.8 x 78.0 mm / 210g	FHD (1080p) model, 1080p60, Great FHD picture quality with 10x lens, Great sensitivity in FHD Min illumination 0.35 Lux, Stable zoom, Wide-D mode, Visibility Enhancer, 2D/3D Noise Reduction, Analogue and Digital Output, Auto ICR, Slow AE Response, Spherical Privacy Zone Masking
FCB-EV5500	1/2.8-type Exmor CMOS	Approx 1.37 Megapixels	30x Optical zoom, 12x Digital zoom	50 x 60 x 89.7 mm / 260g	HD (720p) model, HD picture quality with 30x lens, Great sensitivity in HD Min illumination 0.25 Lux, Image Stabilisation, Stable zoom, Wide-D mode, Visibility Enhancer, 2D/3D Noise Reduction, Analogue and Digital Output, Auto ICR, Slow AE Response, Spherical Privacy Zone Masking
FCB-EV5300	1/3-type CMOS	Approx 1.37 Megapixels	20x Optical zoom, 12x Digital zoom	50 x 60 x 87.9 mm / 270g	HD (720p 60fps) model, HD picture quality with 20x lens and excellent sensitivity, Image Stabilisation, Stable zoom, Wide-D mode, Visibility Enhancer, 2D/3D Noise Reduction, Digital Output, Auto ICR, Slow AE Response, Spherical Privacy Zone Masking
FCB-IV7315	1/2.8-type Exmor CMOS	Approx 2.38 Megapixels	20x Optical zoom, 12x Digital zoom	50 x 60 x 87.9 mm / 270g	FHD (1080p) model, 1080p60, Great FHD picture quality with 20x lens, Great sensitivity in FHD Min illumination 0.1 Lux, Stable zoom, Wide-D mode, Visibility Enhancer, 2D/3D Noise Reduction, Digital Output, Auto ICR, Slow AE Response, Spherical Privacy Zone Masking

HD series

FCB-EH3150	1/4-type Exmor CMOS	Approx 1.43 Megapixels	12x Optical zoom, 12x Digital zoom	44.8 x 46.9 x 71.8 mm / 150g	Excellent High-Definition (HD) picture quality (720p), Min illumination 0.3 Lux, Analogue and Digital Output, Wide-D mode, Auto ICR, Spherical Privacy Zone Masking, Noise Reduction, Slow AE response
FCB-SE600	1/2.8-type Exmor CMOS	Approx 3.27 Megapixels	3x Optical zoom, 12x Digital zoom	50 x 47.6 x 53.4 mm / 83g	Compact size, Motorised zoom and One-Push AF, 1080p 30 FHD image quality, Auto WDR, Motion Detection, Privacy Zone Masking, Noise Reduction

For full features visit www.image-sensing-solutions.eu

© 2017 Sony Corporation. All rights reserved. Reproduction in whole or in part without permission is prohibited. Features and specifications are subject to change without notice. All non-metric weights and measurements are approximate. Sony is a registered trademark of Sony Corporation. All other trademarks are the property of their respective owners.

Distributed by

MachineVisionCatalogue_J6149_UK_01/12/2017

SONY